

EXPLODED VIEW & PARTS LISTING

Air Operated Double Diaphragm pump

Model : NDP-P20BS.

Yamada Europe B.V.



Material: Stainless steel 316 (SCS14)

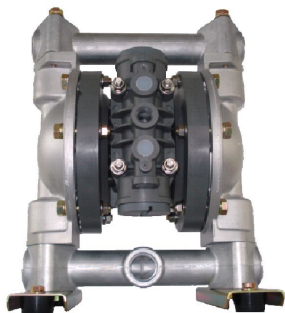

To Purchase:

More information:

☎ 0031 (0)74 242 2032

▶ YouTube: [@yamadapump](https://www.youtube.com/@yamadapump)

✉ sales@yamada.nl

🌐 yamada-europe.com

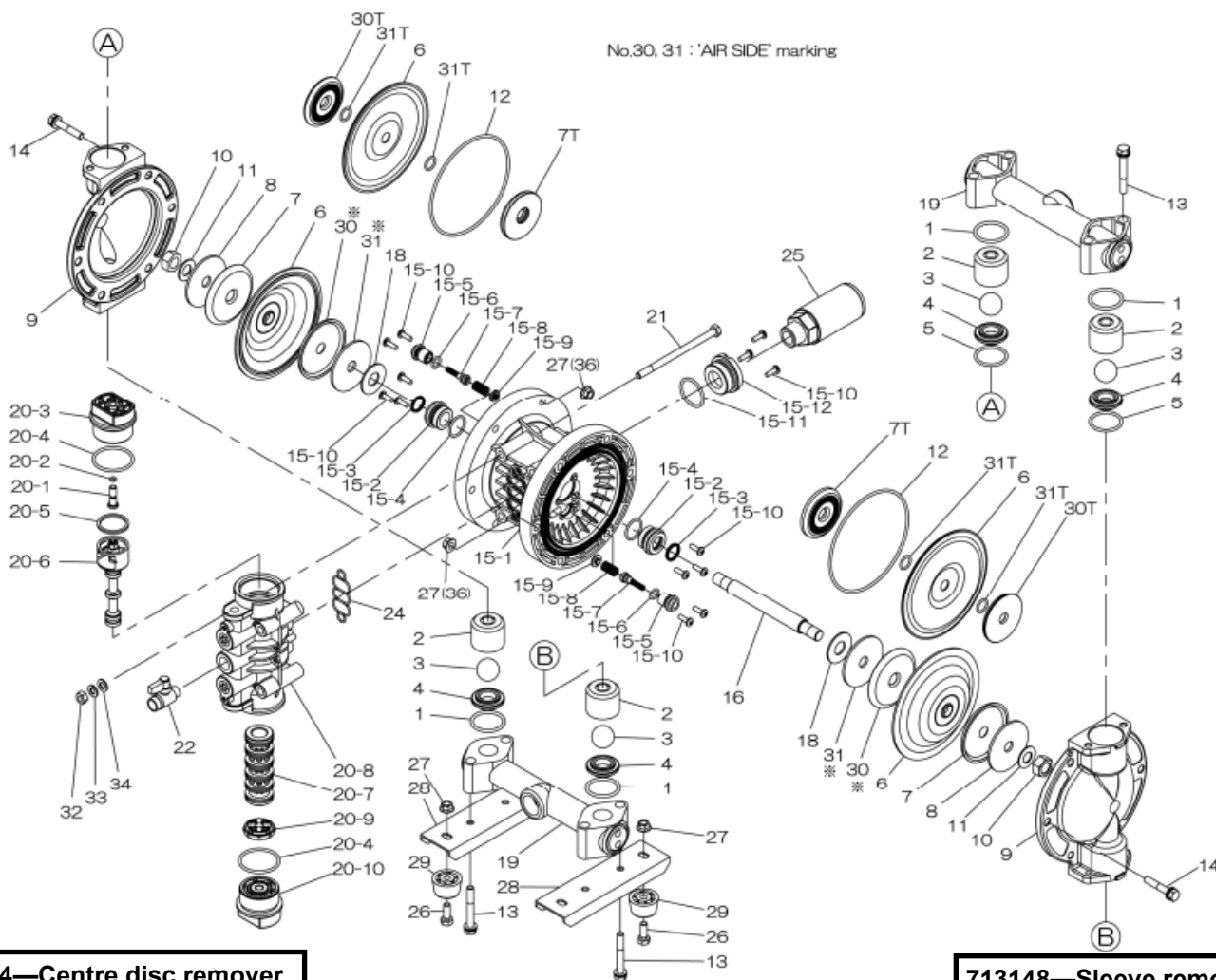

771244—Centre disc remover

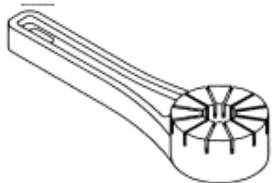

713148—Sleeve remover

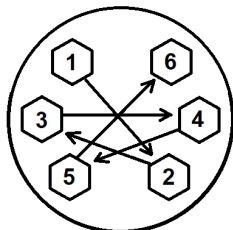
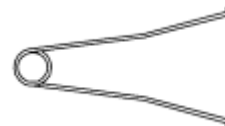

Tighting torque for:

Center rod: 40 Nm
 Center rod TU: **Hand tight**
 Out chamber: 10/20 Nm
 Manifold: 10/20 Nm

Special tools (sold seperately)

713148 Sleeve remover
 771244 Centre disc remover

Miscellaneous:

Assembly oil: use turbine oil none additional class 1
 Equiv. to ISO VGA32 grade
 Use Urea grease grade NLGI No. 2

EXPLODED VIEW & PARTS LISTING

Air Operated Double Diaphragm pump

Model : NDP-P20BS.

Yamada Europe B.V.



Material: Stainless steel 316 (SCS14)

DIAPHRAGM

Design #



CR	NBR	EPDM	HYTREL	SANTOPRENE	FPM	PTFE	PTFE-EPDM
BSC	BSN	BSE	BSH	BSS	BSV	BST	BSTU
854066	854067	854068	854071	854072	854069	854070	YE Original

REF. No.	DESCRIPTION	Q'TY.	Part No.	Part No.	Part No.	Part No.	Part No.	Part No.	Part No.	Part No.	Part No.
1	O RING	4	640036	640036	684118	640036	684118	642036	643036	643036	643036
2	BALL GUIDE	4	711701	711701	711701	711701	711701	711701	711701	711701	711701
3	BALL	4	770705	770720	770723	773126	773170	770726	770736	770736	770736
4	VALVE SEAT	4	711705	711705	711705	711705	711705	711705	711705	711705	711705
5	O RING	2	640132	640132	684117	640132	684117	642132	771131	771131	771131
6	DIAPHRAGM	2	772957	772958	772959	771362	771973	772960	771083	832549	832549
7	CENTER DISK	2	709153	709153	709153	709153	709153	709153	—	—	—
7T	CENTER DISK	2	—	—	—	—	—	—	709456	—	—
8	WASHER	2	709152	709152	709152	709152	709152	709152	—	—	—
9	OUT CHAMBER	2	711693	711693	711693	711693	711693	711693	711693	711693	711693
10	NUT	2	682263	682263	682263	682263	682263	682263	682263	—	—
11	CONED DISC SPRING	2	682730	682730	682730	682730	682730	682730	682730	682730	—
12	O RING	2	—	—	—	640151	640151	—	640151	640151	640151
13	BOLT & WASHER	8	686360	686360	686360	686360	686360	686360	686360	686360	686360
14	BOLT & WASHER	12	686358	686358	686358	686358	686358	686358	686358	686358	686358
15	BODY ASSY	1	804603	804603	804603	804603	804603	804603	804603	804603	804603
16	CENTER ROD	1	709163	709163	709163	709163	709163	709163	709163	709163	714674
18	CUSHION	2	771054	771054	771054	771054	771054	771054	771054	771054	771054
19	MANIFOLD ASSY	2	831245	831245	831245	831245	831245	831245	831245	831245	831245
20	VALVE BODY ASSY	1	804607	804607	804607	804607	804607	804607	804607	804607	804607
21	BOLT	4	686031	686031	686031	686031	686031	686031	686031	686031	686031
22	VALVE	1	686967	686967	686967	686967	686967	686967	686967	686967	686967
24	GASKET	1	772848	772848	772848	772848	772848	772848	772848	772848	772848
25	MUFFLER	1	804697	804697	804697	804697	804697	804697	804697	804697	804697
26	BOLT	4	611148	611148	611148	611148	611148	611148	611148	611148	611148
27	FLANGED NUT	4	682276	682276	682276	682276	682276	682276	682276	682276	682276
28	BASE	2	709157	709157	709157	709157	709157	709157	709157	709157	709157
29	RUBBER FOOT	4	770551	770551	770551	770551	770551	770551	770551	770551	770551
30	CENTER DISK	2	716225	716225	716225	716225	716225	716225	—	772562	772562
30T	CENTER DISK	2	—	—	—	—	—	—	709326	—	—
31	WASHER	2	716226	716226	716226	716226	716226	716226	—	—	—
31T	O RING	4	—	—	—	—	—	—	643013	—	—
32	NUT	4	683635	683635	683635	683635	683635	683635	683635	683635	683635
33	SPRING WASHER	4	681300	681300	681300	681300	681300	681300	681300	681300	681300
34	PLAIN WASHER	4	631329	631329	631329	631329	631329	631329	631329	631329	631329
36	FLANGED NUT	12	686032	686032	686032	686032	686032	686032	686032	686032	686032
KIT	DIAPHRAGM		KP20D-MC	KP20D-MN	KP20D-ME	K20D-MH	K20D-MS	KP20D-MV	K20D-MT	K20D-MTU	K20D-MTU
KIT	VALVE		K20V-SC	K20V-SN	K20V-SE	K20V-SH	K20V-SS	K20V-SV	K20V-ST	K20V-ST	K20V-ST
KIT	WET END REPAIR		K20-MC-1	K20-MN-1	K20-ME-1	K20-MH-1	K20-MS-1	K20-MV-1	K20-MT-1	K20-MTU-1	K20-MTU-1
KIT	AIR MOTOR		KP20/25-AM								
KIT	AIR MOTOR SEAL		KP20/25-AMS								

EXPLODED VIEW & PARTS LISTING

Model : NDP-P20BPS

Yamada Europe B.V.



Air Operated Double Diaphragm pump

Material: Stainless steel 316 (SCS14)



DIAPHRAGM

Design #

CR	NBR	EPDM	HYTREL	SANTOPRENE	FPM	PTFE	PTFE-EPDM
BSC	BSN	BSE	BSH	BSS	BSV	BST	BSTU
854066	854067	854068	854071	854072	854069	854070	YE Original

REF. No.	DESCRIPTION	Q'TY.	Part No.	Part No.	Part No.	Part No.	Part No.	Part No.	Part No.	Part No.
15- 1	BODY	1					772928			
*15- 2	THROAT BEARING	2					772931			
15- 3	PACKING	2					685414			
15- 4	O RING	2					685276			
15- 5	VALVE SEAT	2					772932			
15- 6	O RING	2					640009			
15- 7	PILOT VALVE ASSY	2					802360			
15-7-1	O RING SEAL PILOT VALVE	2					771374			
15- 8	SPRING	2					708666			
15- 9	SPRING SEAT	2					772948			
15-10	TAPPING SCREW	13					686030			
15-11	O RING	1					640132			
15-12	BUSHING	1					772933			
20- 1	RESET BUTTON	1					772991			
20- 2	O RING	1					640002			
20- 3	CAP A	1					772946			
20- 4	O RING	2					640043			
20- 5	PACKING	1					771241			
20- 6	C SPOOL ASSY	1					802400			
20- 7	SLEEVE ASSY	1					804609			
20-7-1	O RING	6					686029			
20- 8	VALVE BODY ASSY	1					832902			
20- 9	CUSHION	1					771914			
20-10	CAP B	1					772947			
KIT	AIR MOTOR						KP20/25-AM			
KIT	AIR MOTOR SEAL						KP20/25-AMS			

! * Throat bearing position 15-2, 772931 is only available as an assembly. Positions 15-2, 15-3 and 15-4. Article code 020931

EXPLODED VIEW & PARTS LISTING

Air Operated Double Diaphragm pump



MODEL : NDP-P20BS.

Model : NDP-P20BS.

Yamada Europe B.V.



Material: Stainless steel 316 (SCS14)

Diaphragm options	CR, NBR, EPDM, FPM, TPEE, TPO	PTFE	TU
Max performance	110 L/min	100 L/min	95 L/min
Manifold connection	Rc 3/4"		
Net Weight	12,5 kg		

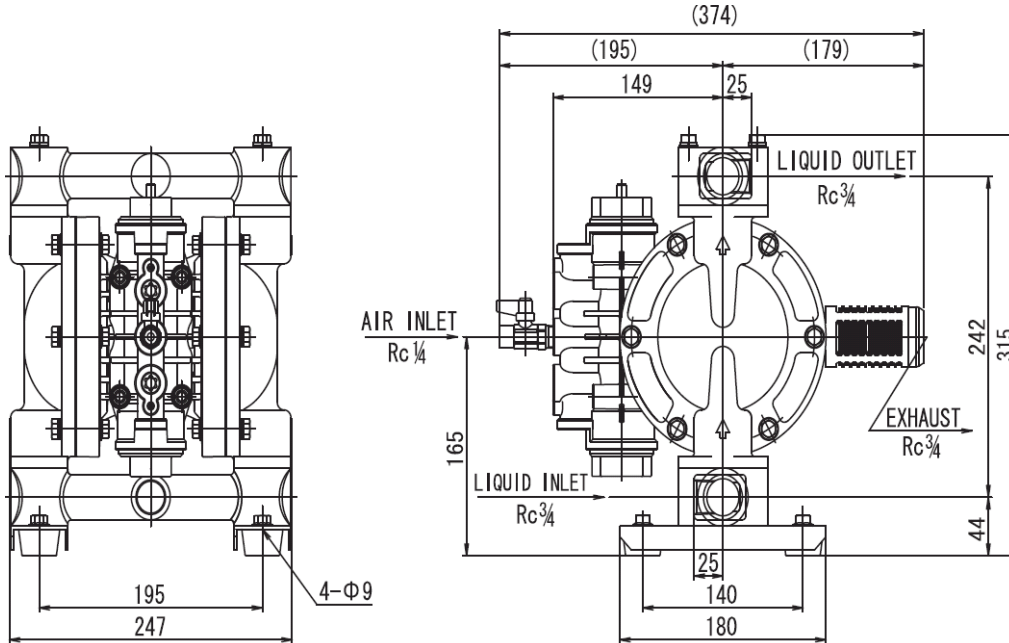

■ NDP-P20BA □/BS □/BP □

0,1MPa = 1Bar

■ NDP-P20BAT/BST/BPT

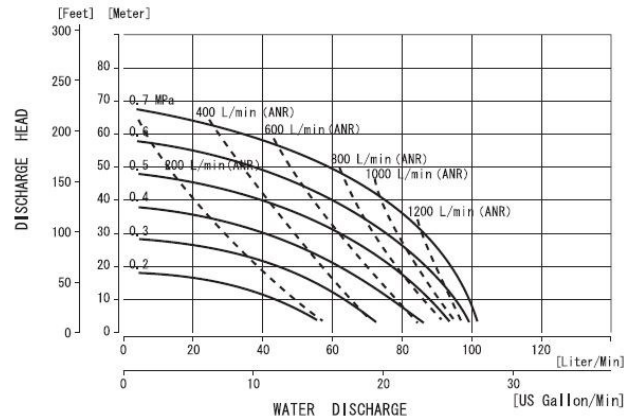
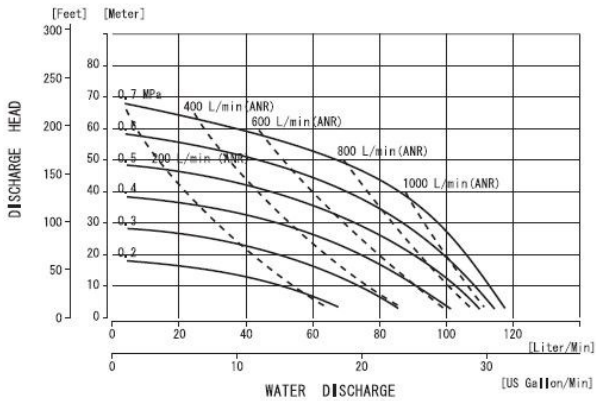

NDP-P20BSTU

